



4 Plate Electric Boiling Table

Model: BT-E/4P
Dimensions: 800 x 800 x 900

Features

Top made from 1.6mm Grade 430 st/steel
Body manufactured from 0.9mm Grade 430 st/steel

Technical Drawing

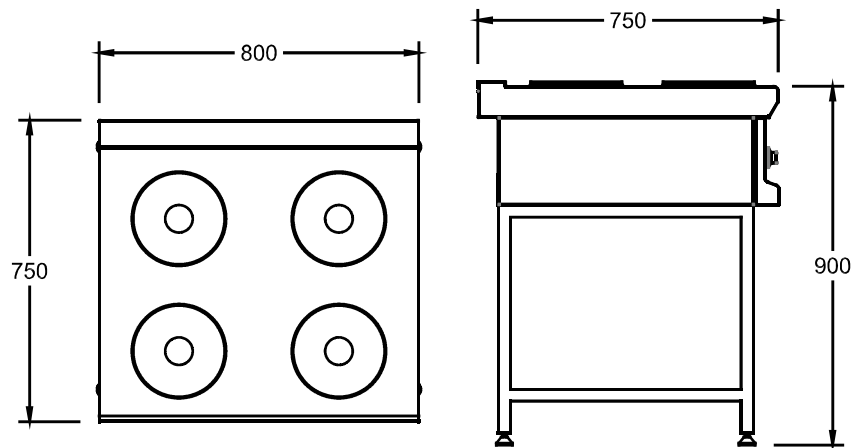

Optional Extras

- Body and top section can be manufactured from 304 s/steel

Specifications

Dimensions: 800 x 800 x 900
No of elements: 4 off
Electrical load: 8 kw, 380v, 3 phase neutral and earth
Electrical connection: 2 meter (5 core) cable with fly lead