



1850 Neutral Counter

Model: NC-1850

Dimensions: 1850 x 750 x 900

Features

Top made from 0.9mm Grade 430 st/steel

Body manufactured from 0.9mm Grade 430 st/steel

Technical Drawing

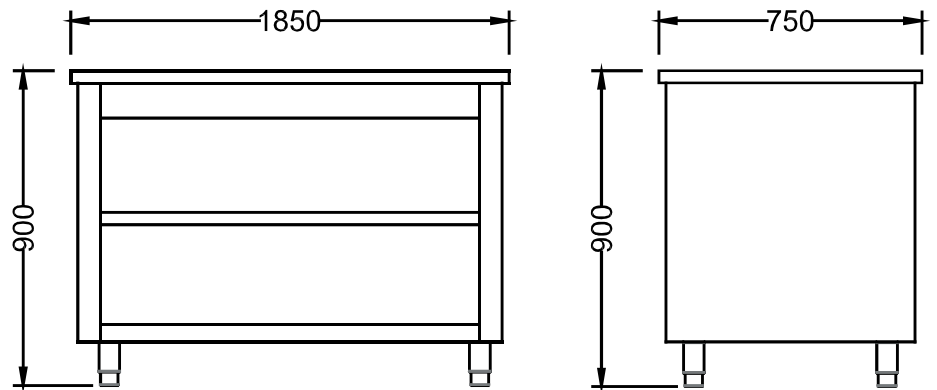

Optional Extras

- Heated cabinet
- Glass sneeze guard
- Tray slides

Specifications

Dimensions: 1850 x 750 x 900