



4 Burner Gas Boiling Table

Model: BT-4
Dimensions: 800 x 800 x 900



Features

Top made from 1.6mm Grade 430 st/steel
Body manufactured from 0.9mm Grade 430 st/steel

Technical Drawing

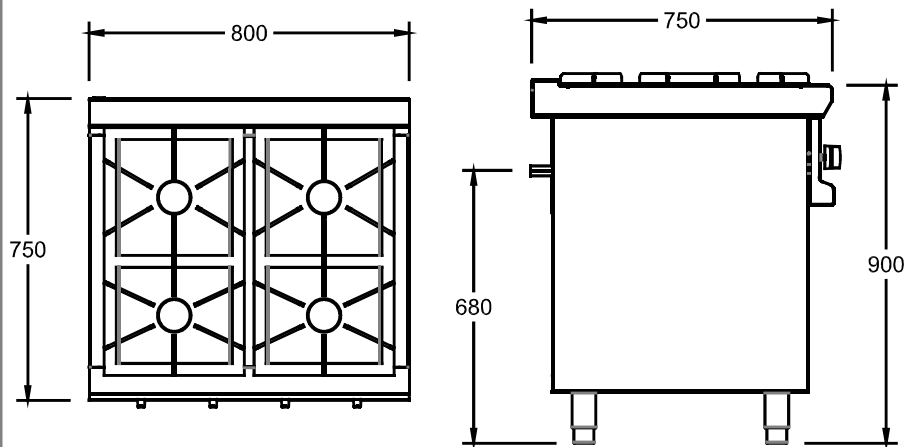

Optional Extras

- Body and top section can be manufactured from 304 s/steel

Specifications

Dimensions: 800 x 800 x 900
No of burners: 4 burners
Gas pressure: LPG: 2.7Kpa
Gas consumption: 2.56 kg/Hr